



Audio Engineering Society Convention e-Brief

Presented at the 143rd Convention
2017 October 18–21, New York, NY, USA

This Engineering Brief was selected on the basis of a submitted synopsis. The author is solely responsible for its presentation, and the AES takes no responsibility for its contents. All rights reserved. Reproduction of this paper, or any portion thereof, is not permitted without direct permission from the Audio Engineering Society.

Design and Implementation of a Practical Long-Throw High-Q CBT Array

D. B. (Don) Keele, Jr¹, Marshall Kay²

¹ DBK Associates and Labs, Bloomington, IN 47408, USA

² Keysight Technologies, Apex, NC 27502, USA

Correspondence should be addressed to the Author (DKeeleJr@Comcast.net)

ABSTRACT

This paper describes the design and construction of a very-tall 5m experimental passive long-throw high-Q CBT array that provides coverage in a large church general-purpose activity room with a full-size basketball court. The room is 7.8 x 20 x 30 m (H x W x L). The 5 m tall 20° circular- arc array contains 80 ea 63.5 mm (2.5") full-range drivers, and provides a tight 15° vertical beamwidth. The mechanically aimed no-DSP passive segmented design is composed of five straight-front boxes each containing 16 drivers. Series-parallel connections, resistive attenuators, and two power amplifiers provide the frequency-independent four-bank CBT shading. This paper also provides detailed simulation data of the array's predicted beamwidth vs. frequency, directivity, vertical polar response, axial foot prints and predicted frequency response at three different downward tilt angles. The array provides very-even coverage along the entire length of the 30 m room.

1 Introduction

Constant Beamwidth Transducer CBT array theory is based on un-classified military under-water transducer research done in the late 70s and early 80s [1, 2]. The research describes a curved-surface transducer in the form of a spherical cap with frequency-independent Legendre shading that provides wide-band extremely-constant beamwidth and directivity behavior with virtually no side lobes. The theory was applied to loudspeaker arrays by Keele in 2000 [3] where he extended the concept to circular-arc line arrays.

This paper describes the design and construction of an experimental passive long-throw high-Q CBT array that provides coverage in a large church general-purpose activity room with a full-size basketball court. The room is about 7.8 x 20 x 30 meters (25.5 x 66 x 98 ft) (H x W x D) and has a mid-band reverb time of about 2 to 2.5 sec.

The array is a very-tall passive 20° segmented circular- arc design with a height of 5 m (16.7 ft) and contains 80 ea 63.5 mm (2.5") diameter full-range drivers, and provides a tight 15° vertical beamwidth.

Two arrays are mounted on the narrow end of the large room on each side of a short elevated stage and

provide stereo coverage for youth groups seated in front of the stage.

The segmented design is composed of five straight-front individual boxes each containing 16 drivers and the design contains no supporting DSP other than in-line EQ before the power amps. Series-parallel connections, a resistive voltage divider, plus two power amplifiers provide the frequency-independent four-bank CBT shading of 0 dB (32 drivers), -2.4 dB (16 drivers), -5 dB (16 drivers), and -9.6 dB (16 drivers). Following CBT free-space array design, the shading is highest in the center of the array and tapers off to either end.

This paper illustrates several detailed simulated aiming scenarios that optimize the vertical direct-field coverage down the center-line of the room. A downward aiming angle of seven degs provides excellent vertical coverage and intelligibility at all locations with a frequency response that fits a tight envelope of about ± 2 dB.

The paper also provides detailed simulation data of the array's predicted beamwidth vs. frequency, directivity, vertical polar response, and axial foot prints of forward projected sound.

Impulse responses of the coverage of the array were gathered at several locations in the room using

ARTA (<http://www.artalabs.hr/>) with the mic physically on the floor to minimize floor interference. When converted to frequency response, the coverage was very good at all locations. Even at several locations very close to the array in the nearfield at 1m from the front surface of the array, the response was quite uniform. This illustrates the fact that a CBT array essentially has no nearfield [1, p. 41 point (3) in the left column]. The response is essentially the same directly in front of the array in the nearfield or at points farther away!

The frequency responses computed from the measured impulse response were very uniform and smooth at all these locations and only dropped 4 dB in the rear of the room 85 ft away!

Unfortunately due to paper size constraints, these impulse and frequency response measurements are not shown in this paper.

2 Room Description and Dimensions

The room provides space for large youth church meetings where music is played quite loud with the arrays augmented by powerful subs. Both arrays are located on either side of a small stage and raised up and placed against the wall.

In this room, the bottoms of the arrays are about 5 ft above the floor. At this location and with the systems playing very loud in the audience area, the CBT's off-axis attenuation is so great that you can walk right up and stand directly below the arrays and carry on a conversation with someone standing next to you! Even the fidelity is quite good at this location also but greatly reduced in level compared to the level in the audience!

The room's dimensions are 7.8 x 20.1 x 29.9 m (25.5 x 66 x 98 ft), H x W x D, and includes a full-size basket-ball court. The gross internal volume is about 4670 cu m (165,000 cu ft).

3 Array Parameters

The array parameters were chosen to provide even coverage at all points from the front to the rear of the long 30 m (98 ft) room from a point 4.9 m (16 ft) above the floor.

This necessitated a narrow array vertical beamwidth of about 15° which implies a CBT array with a 20° CBT circular arc.

The height of the array governs the frequency down to which vertical beamwidth is maintained. The tallest array which would reasonably fit the space was about 5 m (17 ft.). This size provided

beamwidth control down to about 400 Hz (see Fig. 6 later).

4 Array Implementation

The mechanically aimed segmented design is composed of five straight-front individual 4° wedge boxes each containing 16 drivers.

The design contains no supporting DSP other than in-line EQ before the power amps. Passive internal CBT array shading is provided by series-parallel connections, passive resistive attenuators, and two power amplifiers which provide the frequency-independent four-bank CBT shading.

4.1 Number of Drivers

The 5 m height of the array allowed 80 each 63.5 mm (2.5") drivers to be used. The driver chosen was the wide-range Dayton Audio model ND65 (<https://www.parts-express.com/dayton-audio-nd65-8-2-1-2-aluminum-cone-full-range-driver-8-ohm--290-206>).

4.2 Shading

A four-bank shading design was chosen to implement the CBT Legendre shading [4]. Here are the four banks showing the attenuations and the number of drivers in each bank:

1. Bank 1: +0.0 dB (32 drivers),
2. Bank 2: -2.4 dB (16 drivers),
3. Bank 3: -5.0 dB (16 drivers), and
4. Bank 4: -9.6 dB (16 drivers).

The following Fig. 1 shows the individual stepped attenuations along with the continuous truncated Legendre curve.

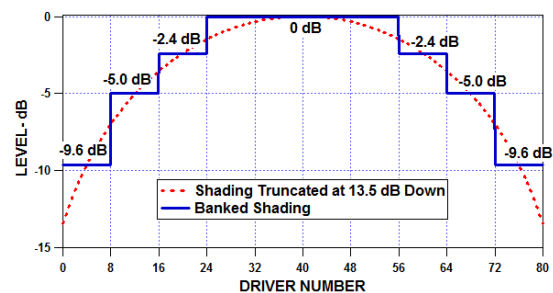

Fig. 1. The banked shading (blue solid line) used by the long-throw array. The shading is a stepped approximation to a continuous truncated at -13.5 dB Legendre curve (red dashed line).

Note that this stepped attenuation follows a CBT free-space design [5] (not a ground-plane design) with the shading maximum in the center of the array and tapering off to either end.

4.3 Wiring and Amplifiers

The banked shading for the 80 drivers is implemented by series-parallel connections and a resistive voltage divider for the highest-attenuation -5 and -9.6 dB banks [4]. One channel of a two-channel amplifier separately drives the 32 speakers in the zero-attenuation (0 dB) bank and the second channel drives the remaining 48 speakers with gain set to -2.4 dB.

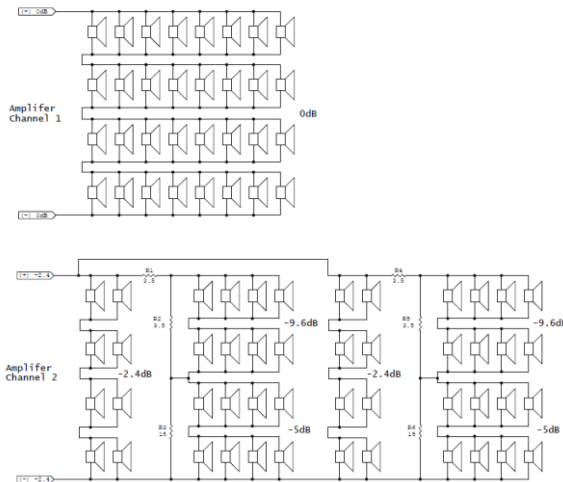

Fig. 2. Circuit diagram for the four-bank array providing shading for all 80 drivers. The top circuit is driven by an amplifier set to 0 dB gain while the bottom circuit is driven by an amplifier set to -2.4 dB gain. The circuit implements a four-bank stepped shading of respectively 0, -2.4, -5.0, and -9.6 dB. The highest attenuations of -5.0 and -9.6 dB are implemented with a resistive voltage divider (circuit banks on bottom right).

4.4 Array Segmentation and Mechanics

The 20° array is a segmented circular-arc array design [6] implemented with five *straight-front* enclosures each housing 16 each drivers. Each enclosure is a 4° wedge box with 2° angles on top and bottom.

4.4.1 Enclosure

The straight-front enclosure housing 16 drivers is shown in Fig. 3. The box dimensions are roughly 1 x 0.10 x 0.2 m (40.8" x 4.0" x 8.375") with a wedge angle of 4°.

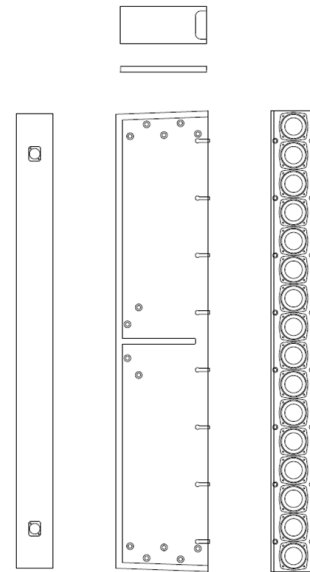

Fig. 3. Drawing of the straight-front wedge enclosure housing 16 ea 63.5 mm (2.5") drivers. The box dimensions are roughly 1 x 0.10 x 0.2 m (40.8" x 4.0" x 8.375") with a wedge angle of 4° (2° on top and bottom).

4.4.2 Connector Plate

Eight connector plates (Fig. 4) are required to attach the five straight-front 4° wedge enclosures to form the 20° array.

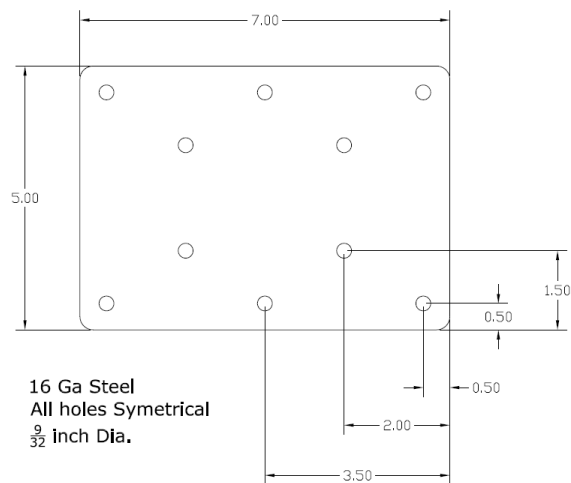

Fig. 4. Connector plate drawing required for array assembly. Four of these 127 x 177.8 mm (5" x 7") plates are required on either side of the array to attach the five flat-front enclosures together (eight plates in all). All dimensions in inches.

4.4.3 Complete Array

The complete 5 m tall 20° segmented array is shown in Fig. 5 and is composed of five enclosures (Fig. 3)

attached together with eight connector plates (Fig. 4.). Although the array is essentially a circular arc that bulges in the front, the total depth of the array is only about 0.4 m (16.5”). The array could be housed in a straight-front grill that disguises the curve of the array.

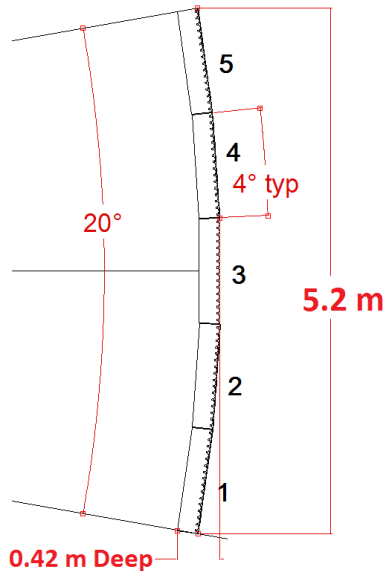

Fig. 5. The complete array is composed of five straight-front cabinets each housing 16 drivers making 80 drivers. The array is about 5 m (17 ft) tall and is a 20° segmented circular arc. The array depth is only 0.4 m (16.5”). The assembled array requires eight connector plates, four on either side (Fig. 4).

5 Array Simulations

This section displays several simulations of the array itself including: beamwidth, directivity, power loss, vertical polars, and axial footprints (Sections 5.1 – 5.5).

Section 5.5 goes into detail concerning array aiming where the simulations determine that the best downward tilt angle and aiming location that provides the best coverage and frequency response from front to rear of the room along its center line.

All the array simulations were accomplished with a point-source computer model described in [3, Section 3.1 and Section 6, Appendix].

5.1 Beamwidth vs. Frequency

The array’s simulated beamwidth vs. frequency at third-octave centers is shown in Fig. 6.

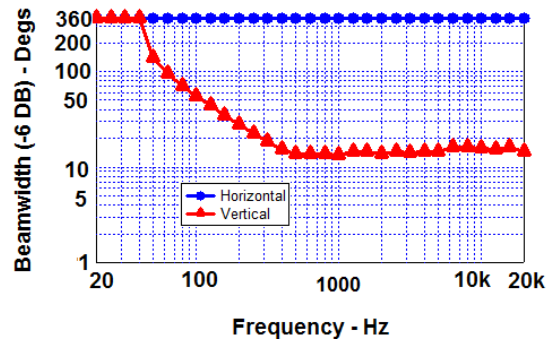

Fig. 6. Simulated array beamwidth vs. frequency plotted at one-third octave intervals. Above 400 Hz, the vertical beamwidth (red triangles) is about 15° while the horizontal beamwidth (blue circles) is 360°.

The simulated vertical beamwidth is extremely uniform above 400 Hz at about 15 degs only between 13.5 to 16.3 degs!

5.2 Directivity

The array’s simulated directivity index and directivity factor (Q) vs. frequency at third-octave centers is shown in Fig. 7.

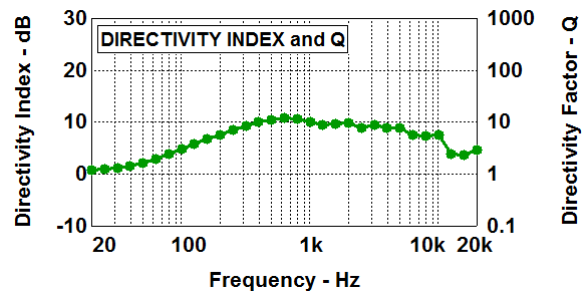

Fig. 7. Simulated array directivity index and directivity factor (Q). Between 400 Hz and 5 kHz the directivity index is high at about 10 dB.

The simulated directivity index was quite uniform at about +10 dB over the range of 300 to 5 kHz.

The simulations shown in Figs. 6 and 7 confirm the extremely uniform beamwidth and directivity behavior of a CBT array! This CBT array is a truly wideband constant-directivity and constant-coverage device!

5.3 Power Loss

The array’s simulated power loss or (on-axis loss) vs. frequency at third-octave centers is shown in Fig. 8. Above 600 Hz the power rolls of at 3 dB/octave. As noted in the figure caption, this rolloff is an inherent feature of circular-arc arrays and not only circular-arc CBT arrays!

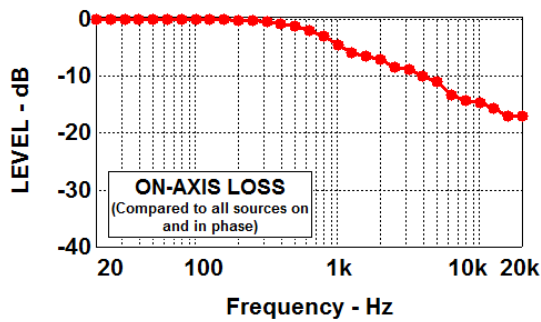

Fig. 8. Simulated array power-loss. Above 6 kHz the loss rolls off at about 3 dB/octave or 10 dB/decade. This is an inherent feature of circular-arc arrays.

5.4 Vertical Polars

Several simulated vertical polars between 800 Hz and 12.5 kHz at octave centers are shown in Fig. 9. Note the extreme uniformity of the polars and the absence of side lobes. Above 10 kHz strong off-axis side lobes are exhibited due to driver-to-driver spacing at high frequencies.

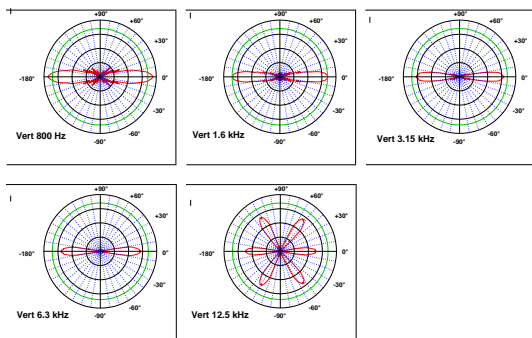

Fig. 9. Simulated array vertical polars plotted over the range of 800 Hz to 12.5 kHz at octave centers. Above 10 kHz off-axis grating lobes are exhibited. These polars are unnormalized which means the on-axis level is not maintained constant with frequency.

5.5 Axial Footprints

Several simulated axial foot prints between 800 Hz and 12.5 kHz at octave centers are shown in Fig. 10. Note the extreme uniformity of the foot prints below 12.5 kHz. An axial foot print is a plot of the sound pressure level over a range of $\pm 60^\circ$ Vert. $\times \pm 60^\circ$ Hor. from on axis.

Note how the vertical coverage narrows as you go off axis horizontally. This is an inherent feature in the full-sphere sound-field of a CBT array [7].

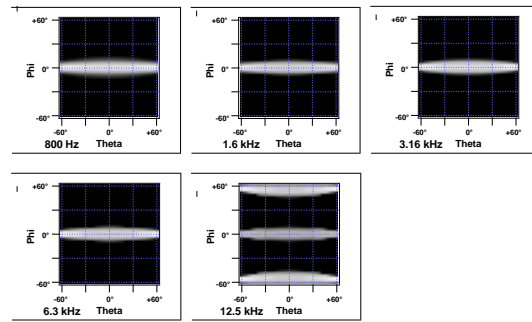

Fig. 10. Simulated array axial footprints ($\pm 60^\circ$ Vert. $\times \pm 60^\circ$ Hor.) plotted over the range of 800 Hz to 12.5 kHz at octave centers.

5.6 Array Aiming

This paper illustrates several detailed aiming scenarios with simulations that optimize the center-line direct-field coverage over the complete length of the room.

In every case the center of the array is located roughly 4.9 m (16 ft) above the floor on the narrow end of the room.

Sub section 5.6.1 considers the coverage of a reference point source located in the same location as the array.

Sub sections 5.6.2 to 5.6.4 consider array aiming angles of 0 degs, (straight ahead), 7 degs down, and 12 degs down.

A downward aiming angle of about seven degs that points the array at the head of the farthest listener provides the best vertical coverage at six locations down the center of the room from 3m (10 ft) at the front of the room to 26 m (85 ft) in the back of room.

5.6.1 Point Source Reference

The predicted frequency response of a reference point source is shown in the following two figures. The point source is located 4.9 m (16 ft) above the floor at the same location as the center of the array.

Fig. 11 shows a side view of the room with six frequency-response sample locations distributed along the center line of the room. The sample points start at 3 m from the array and extend out to 26 m (the assumed location of the farthest listener) with five increments of 4.5 m.

The center sample point located 12.2 m (40 ft) from the speaker was chosen as a point to equalize both level and frequency response of the radiation of the speaker.

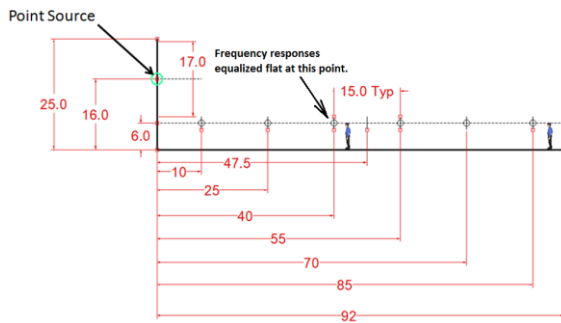

Fig. 11. Side view of room illustrating a point source located 4.9 m (16 ft.) above the floor. Six frequency-response sample points at a head height of about 1.8 m (6 ft) are located at distances starting at 3 m (10 ft) and extending to 26 m (85 ft.) at five increments of about 4.5 m (15 ft.). The sample point midway between the front and the back was chosen as an equalization location. The diagram shows all dimensions in feet.

Fig. 12 shows the predicted frequency response at all six sample points from near to far along the rooms center line. The left image shows the raw un-equalized frequency response, while the right image shows the equalized frequency response when the response is equalized flat at the midpoint location.

The distance color codes for all the following frequency responses are shown in the following diagram:

- DISTANCE:**
- 3.0 m (10 ft)
 - 7.6 m (25 ft)
 - 12.2 m (40 ft)
 - 16.8 m (55 ft)
 - 21.3 m (70 ft)
 - 25.9 m (85 ft)

As expected, the point source provides absolutely flat frequency response at all locations, however, its level drops dramatically from front to rear dropping some 16 dB!

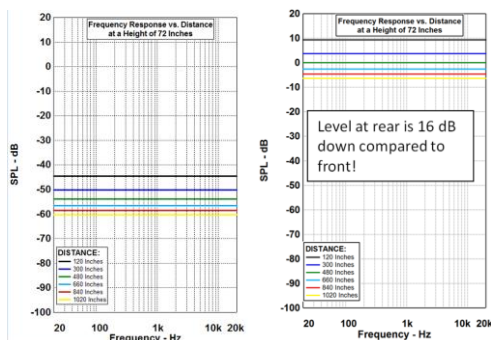

Fig. 12. Predicted frequency response at the six distances described in Fig. 11. The left graph illustrates the raw un-equalized responses while the right graph shows the equalized response with the response equalized flat at the midpoint location 12.2 m (40 ft) (see Fig. 11.).

5.6.2 Aim Straight Ahead: 0°

Fig. 13 shows the side-view diagram and the two sets of frequency responses for the array aimed straight ahead at 0°.

The un-equalized curves on the bottom left clearly show the CBT array’s 3 dB/octave power rolloff above 300 Hz. When mid-point equalized (bottom right), the curves fit a fairly tight envelope but exhibit a rough response below 10 kHz. Also clearly shown above 10 kHz is the chaotic response due to the center-to-center spacing of the drivers exceeding their half wave length spacing at high frequencies.

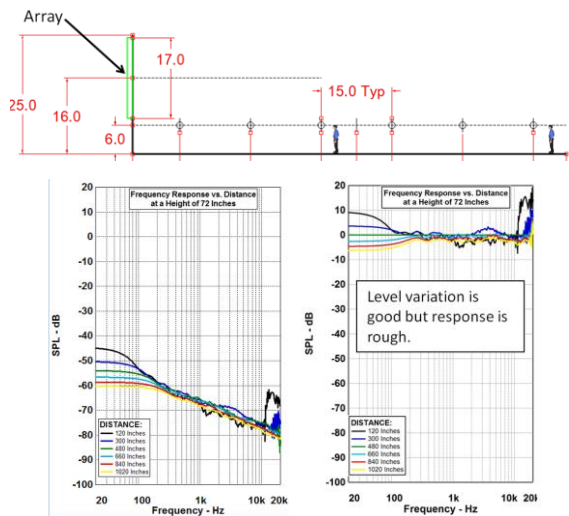

Fig. 13. Side view of space (top) with raw un-equalized frequency responses (left bottom) and equalized responses (right bottom). The array (green) is at the left raised with its center located 4.9 m (16 ft.) above the floor and aimed straight ahead at 0°.

5.6.3 Aim Down at Rear: -6.7°

Fig. 14 shows the side-view diagram and the two sets of frequency responses for the array aimed down at 6.7° towards the head of the farthest listener.

As before, the un-equalized curves on the bottom left clearly show the CBT array’s 3 dB/octave power rolloff above 300 Hz. When mid-point equalized (bottom right), the curves fit a very-tight envelope of 4 dB between 300 Hz and 10 kHz and all the curves exhibit a smooth overall response. Above 10 kHz, the nearest sample point (black curve) exhibits chaos.

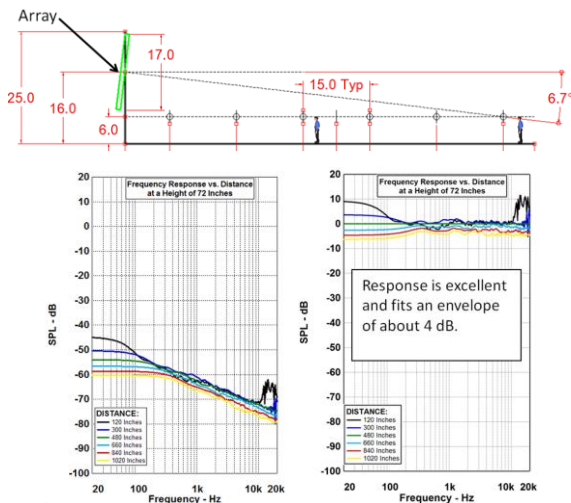

Fig. 14. Side view of room (top) with raw un-equalized frequency responses (left bottom) and equalized responses (right bottom). The array (green) is at the left raised with its center located 4.9 m (16 ft.) above the floor and aimed down 6.7° at the head of the farthest listener.

5.6.4 Aim Down at Center: -11.9°

Fig. 15 shows the side-view diagram and the two sets of frequency responses for the array aimed down at 11.9° aimed towards the center of the room.

Again, the un-equalized curves on the bottom left clearly show the CBT array’s 3 dB/octave power rolloff above 300 Hz. When mid-point equalized (bottom right), the curves are very smooth but only fit a much greater envelope of 8 dB between 300 Hz and 10 kHz.

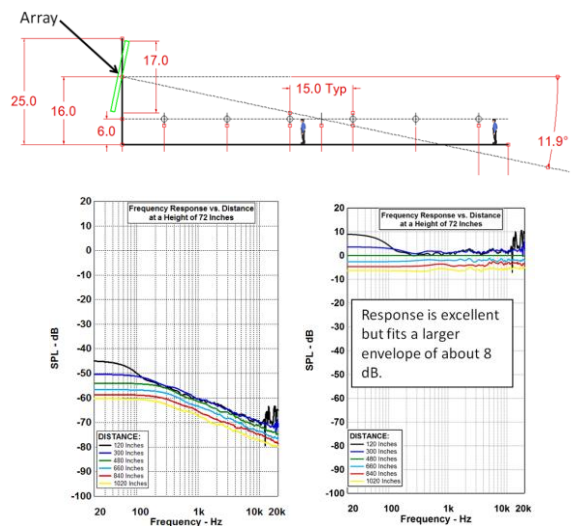

Fig. 15. Side view of space (top) with raw un-equalized frequency responses (left bottom) and equalized responses (right bottom). The array (green) is at the left raised with its center located

4.9 m (16 ft.) above the floor and aimed down 11.9° at the head of the middle listener at a distance of 12 m (40 ft).

5.6.5 Aiming Conclusions

The simulations for the three aiming angles clearly show the superiority of the 6.7° down angle when the array is aimed at the farthest listener. This was the angle chosen for the physical aiming of the array in the room.

6 Array Photos

The following three figures (Figs. 16 – 18) show photos of the array mounted in place. Fig. 16 shows complete photos of the right and left arrays while Fig. 17 shows two close-up views. Fig. 18 shows an oblique photo of the side and rear of an array showing the four side connecting plates and the short Speakon cables connecting one box to the next.



Fig. 16. Photos of complete arrays located in room. Left array is on left photo and right array is on right. Note the doorways on the bottom of each photo for scale. Note also the white video screen in each photo. See Appendix for long shots of room.



Fig. 17. Close-ups of the front of the array. Note hand in right photo for scale.



Fig. 18. Back view of array showing side mounting plates and connections between the array wedge boxes with short Speakon cables

7 Array Measurements

Detailed impulse responses of the coverage of the array were gathered at several locations in the room using ARTA (<http://www.artalabs.hr/>) with the mic physically on the floor to minimize floor bounce.

When converted to frequency response, the coverage was very good at all locations. Even at several locations very close to the array in the nearfield at about 1 m from the front surface of the array, the responses were quite uniform and agreed quite well with the distant in-room responses.

Unfortunately, as noted in the introduction these impulse and frequency response measurements were removed from the paper due to AES paper-size constraints.

8 Conclusions

This paper has shown that a very-viable long-throw high-directivity array can be constructed using relatively simple CBT techniques. The array has broadband constant directivity/beamwidth and does not require any sophisticated DSP processing capability.

The CBT technology allows a very-simple and straightforward passive array to be implemented that provides excellent performance results. The very-tall 5 m array is a segmented design using five straight-front 4° wedge enclosures held together with eight side-mounted connector plates.

Each of the five wedge enclosures house 16 wide-range 63.5 mm (2.5") drivers making 80 drivers in all. No tweeters required!

The mechanically-aimed narrow-angle array provides very even coverage over the entire length of the 30 m long room from a point elevated only 5 m above the floor.

References

- [1] P. H. Rogers, and A. L. Van Buren, "New Approach to a Constant Beamwidth Transducer," *J. Acous. Soc. Am.*, vol. 64, no. 1, pp. 38-43 (1978 July).
- [2] A. L. Van Buren, L. D. Luker, M. D. Jevnager, and A. C. Tims, "Experimental Constant Beamwidth Transducer," *J. Acous. Soc. Am.*, vol. 73, no. 6, pp. 2200-2209 (1983 June).
- [3] D. B. Keele, Jr., "The Application of Broadband Constant Beamwidth Transducer (CBT) Theory to Loudspeaker Arrays," 109th Convention of the Audio Engineering Society, Preprint 5216 (Sept. 2000).
- [4] D. B. Keele, Jr., "Practical Implementation of Constant Beamwidth Transducer (CBT) Loudspeaker Circular-Arc Line Arrays," Presented at the 115th Convention of the Audio Engineering Society (Oct. 2003).
- [5] D. B. Keele, Jr., "Ground-Plane Constant Beamwidth Transducer (CBT) Loudspeaker Circular-Arc Line Arrays," Presented at the 119th Convention of the Audio Engineering Society (Oct. 2005).
- [6] D. B. Keele, Jr., "Implementation of Segmented Circular-Arc Loudspeaker Arrays," Presented at the 137th Convention of the Audio Engineering Society, e-Brief 159 (Oct. 2014).
- [7] D. B. Keele, Jr., "The Full-Sphere Sound Field of Constant Beamwidth Transducer (CBT) Loudspeaker Line Arrays," Presented at the 114th Convention of the Audio Engineering Society (Mar. 2003).

9 Appendix: Long Shot Photos of Stage End of Room with Arrays in Place



Fig. 19. Long shot of room with audience chairs. Note arrays on either side of stage. Subs are located under stage.



Fig. 20. Closer long shot with stage, video screen, and arrays on either side of stage,